



PERSEO





PERSEO

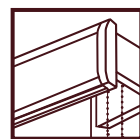

FINITURE / FINISHES

67 = alluminio lucido
bright aluminium

25 = alluminio colore acciaio satinato
aluminium - satined steel color

65 = oro opaco
mat gold



67



25



65

IN COPERTINA MODELLO NELLA FINITURA ORO OPACO
IN COVER MODEL IN MAT GOLD FINISH

CASABLANCA collection

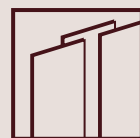
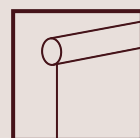

Codice tessuto / Fabric reference	AL104031	AL956232	AL911832
Composizione / Basic material	100 % Cotone / 100 % Cotton	66 % Cotone / Cotton 34 % Poliestere / Polyester	100 % poliestere / 100 % polyester
Finitura / Finishing	Finitura rigida / Stiff finish Candeggiato / Bleached	Finitura rigida / Stiff finish Tinto / Dyed	Finitura rigida / Stiff finish Tinto / Dyed
Retro / Backside	-	Alluminio / Aluminium	Alluminio / Aluminium
Tessuto ignifugo / Flame-retardant	No	No	No
Adatto per ambienti umidi / Suitable for moist atmosphere	No	No	Sì / Yes
Adatto per uffici / Suitable for office environment	Sì / Yes	Sì / Yes	Sì / Yes

		AL104031	AL956232	AL911832
Larghezza finale / Final width		200 cm	200 cm	200 cm
Peso tessuto / Fabric weight		390 g/m ²	260 g/m ²	230 g/m ²
Spessore / Thickness DIN EN ISO 5084		0,60 mm	0,40 mm	0,30 mm
Alterazione dei colori alla luce: lato finestra / Light fastness: window-side DIN ISO 105 – B02	tasso / rating	≥ 5-6	≥ 5-6	≥ 5-6
Restringimento umidità: (%) Moisture shrinkage: (%)		65 % RH, 25° C: < 1 % 90 % RH, 25° C: < 2 %	max. 2	max. 1
Fattori termici e ottici / Thermal and optical factors		In base al colore (vedere scheda specifica) / Depending on colour (see specific card)		
Consigli per la manutenzione / Care instruction		Rimuovere la polvere con un aspirapolvere. Pulire delicatamente con una spugna e con un detersivo delicato. Non mettere a bagno, non usare solventi e non strofinare. Vacuum cleaning. Cleaning by gentle wiping with a sponge and a soft detergent. Do not soak, do not use any other solvents and do not rub.		

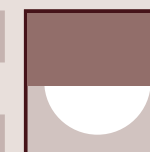

I dati forniti sono valori medi e sono soggetti a variazioni entro le tolleranze utilizzabili.
All details are only average values and are subject to change within usable tolerances.



INFORMAZIONI AMBIENTALI

Tessuto fabbricato senza l'aggiunta di sostanze dannose alla salute come formaldeide, CFC, solventi, componenti di piombo, cadmio, mercurio.
Prodotto senza PVC. Certificato in conformità con lo standard Öko-Tex 100 IV, regolarmente controllato.
Processo produttivo finalizzato a minimizzare l'impatto sull'ambiente e sulle risorse naturali.

ENVIRONMENTAL INFORMATION

This fabric is manufactured without the addition of substances that might be a health hazard such as formaldehyde, CFC, solvents, lead/cadmium/quicksilver compounds.
This product is PVC-free. It is certified in accordance with the Öko-Tex Standard 100 IV and is regularly monitored.
The entire manufacturing process is designed to minimise any impact on the environment and natural resources.

SISTEMA RULLO

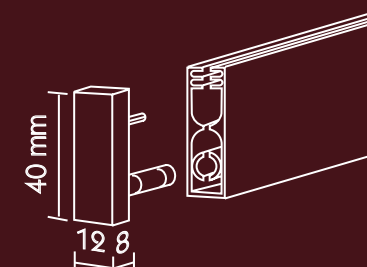
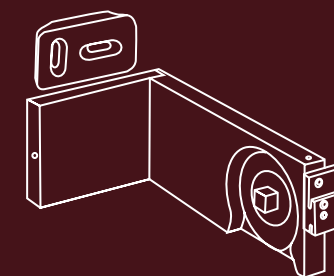
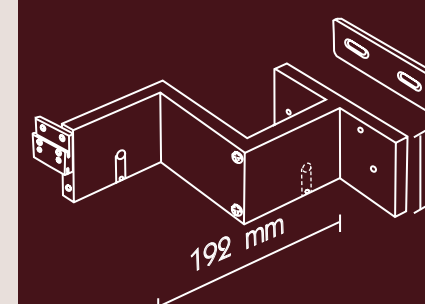
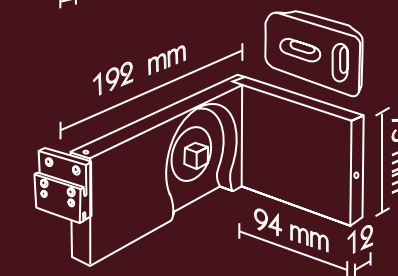
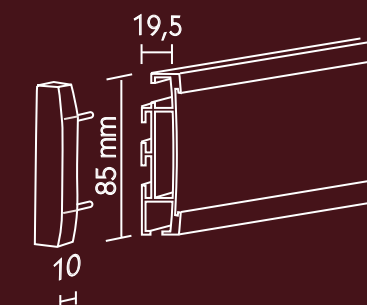

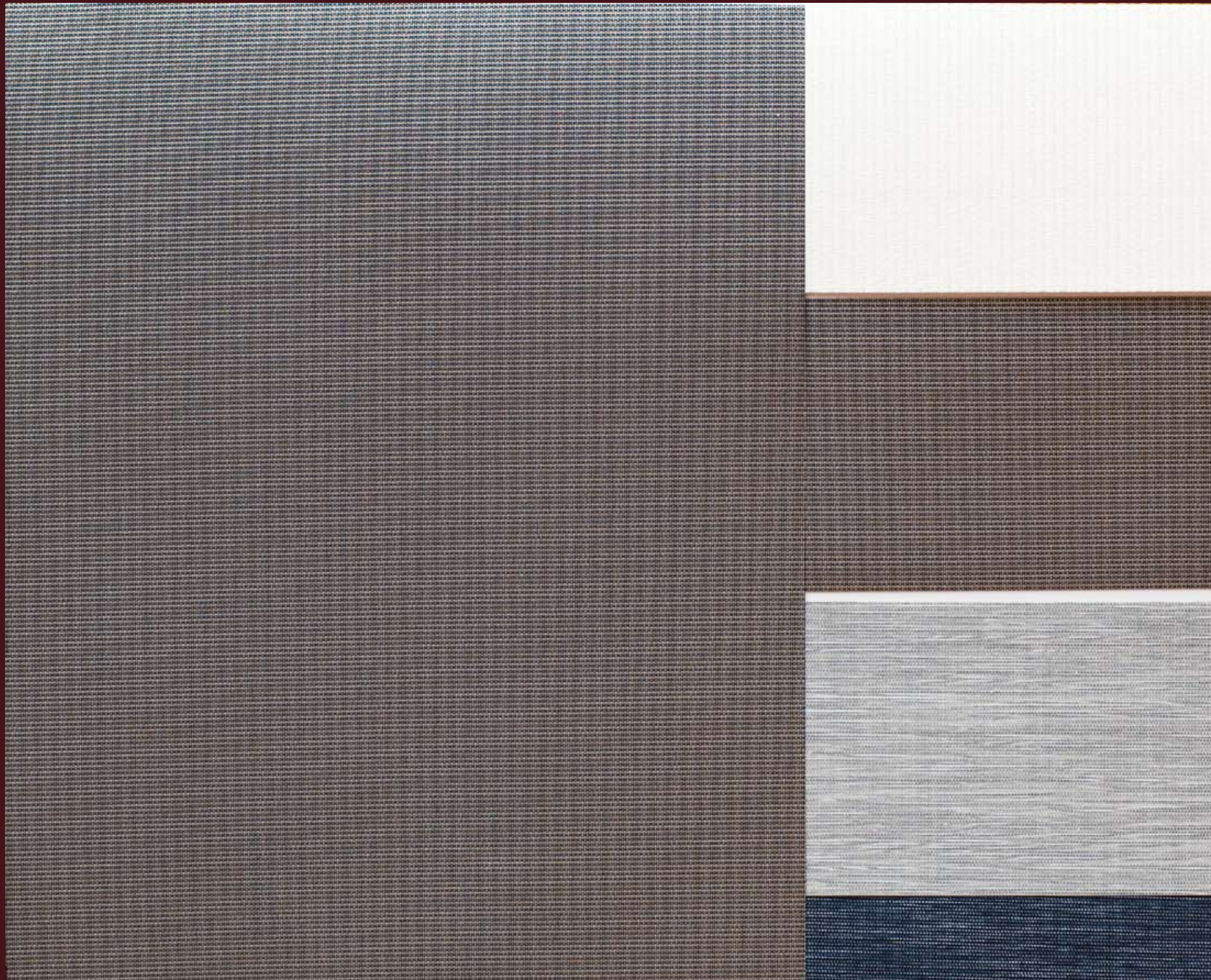

AL104031-08/200

AL911832-01/200

AL956232-05/200

AL956232-09/200

CASABLANCA
collection

